



COMFORT RE

ELECTROMECHANICAL GEAR MOTOR WITH ARTICULATED ARM FOR SWING GATES WITH LEAVES UP TO 2.3 m, 24 V DC



MODELS

CODE	DESCRIPTION	WEIGHT
 178 382	RE2224 24 V DC gear motor for swing gates with max. length 2.3 m	10.5 kg
 178 383	RE2224S 24 V DC gear motor for swing gates with max. length 2.3 m (without control unit)	8.0 kg

ACCESSORIES & SPARES



ELS-C
Horizontal 12 V
electrical lock

178 391

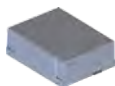

KBP
Battery back-up kit
1.3 Ah

178 392



KC
Unlock key cylinder

178 394



REV1
Slide arm

178 395



REV2
Slide arm for reduced
openings
(E.g. pedestrian gates)

178 463



REV3
External release
unlock kit

178 396



CBX20224
Control unit without box
for two 24 V DC motors,
built-in receiver

178 460

PLUS

Ideal for narrow columns or pillars with reduced dimensions

Compact shape and silent movement, made of strong die-cast aluminum and UV-resistant covers

Double mechanical stop included

Articulated arm gear motor designed for swing gates made of aluminum, PVC or wood leaves

Back-up battery on board (optional)



stylish design
screwless at sight



built-in limit switches



compact dimensions
(width 12 cm)

DIMENSIONS

LIMIT USE

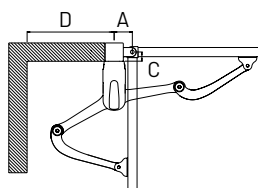
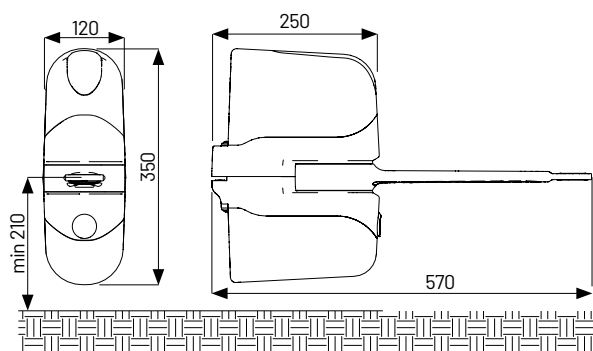

A min.	100
C max.	200
D min.	450

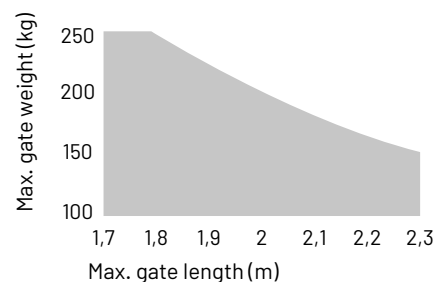

Gate shape and height as well as weather conditions can considerably reduce the max. gate length as shown above in the graph.

TECHNICAL SPECIFICATIONS

		RE2224	RE2224S
Torque	Nm	120	120
Working cycle	%	80	80
Opening time at 90°	sec	14-20	14-20
Control unit		CBX20224	-
Power supply	V AC	230	-
Power supply	V DC	-	24
Absorption	A	0.6	2
Engine power	W	115	50
Encoder		no	no
Protection class	IP	44	44
Dimensions (L - W - H)	mm	120 - 250 - 350	120 - 250 - 350
Weight	kg	10,5	8
Operating temperature	°C	-20° to +55°	-20° to +55°
Leaves max. weight	kg	250	250

KIT COMFORT RE

ELECTROMECHANICAL GEAR MOTOR WITH ARTICULATED ARM FOR SWING GATES WITH LEAVES UP TO 2.3 m, 24 V DC

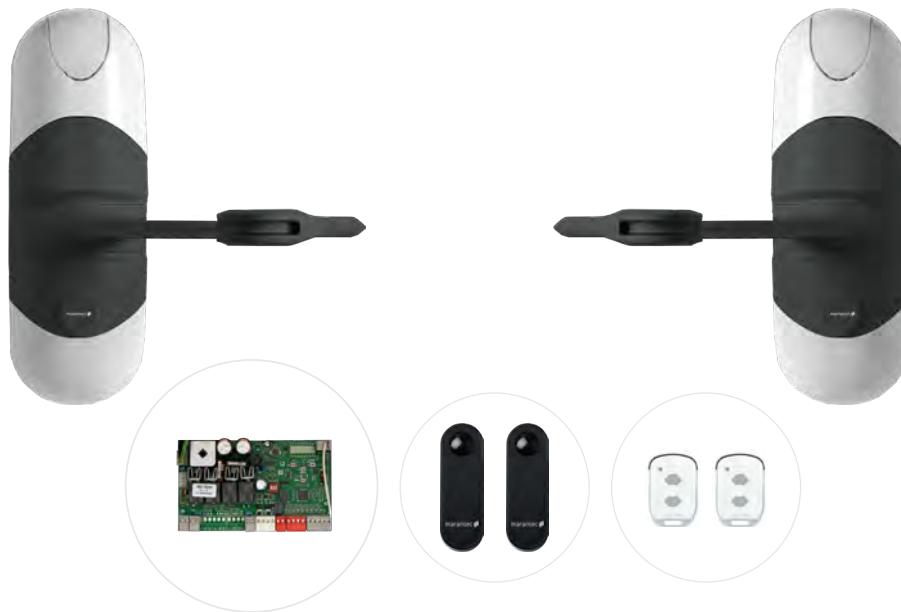

MODELS

CODE	DESCRIPTION	WEIGHT
 178 374	KRE2224 Kit for swing gates with leaves up to 2.3 m, 24 V DC motor with articulated arms, control unit CBX20224 with slowdown, mechanical stops included, built-in receiver 868 MHz bi-linked	18,4 kg

KIT COMPONENTS



Comfort RE



CBX20224



LS22



Digital 572

KRE2224

• 2 pcs

•

•

• 2 pcs

